

BYSTRONIC PART: 3-06607

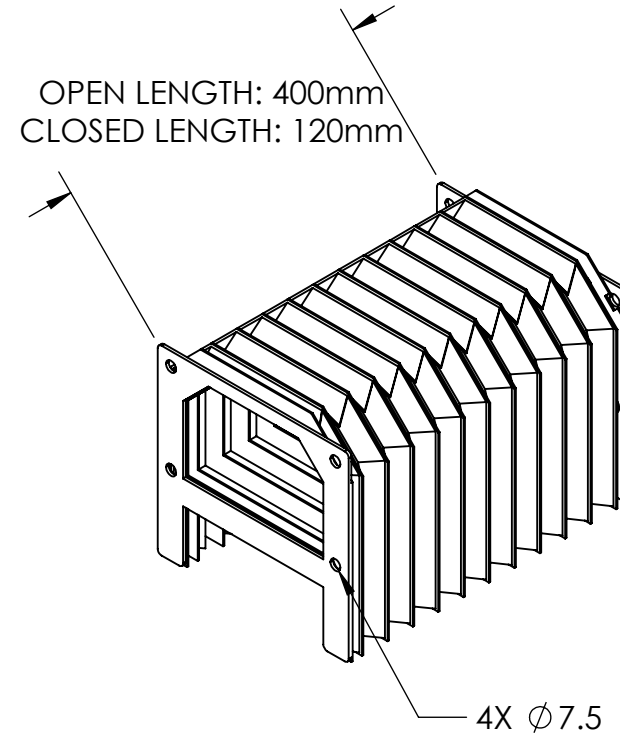
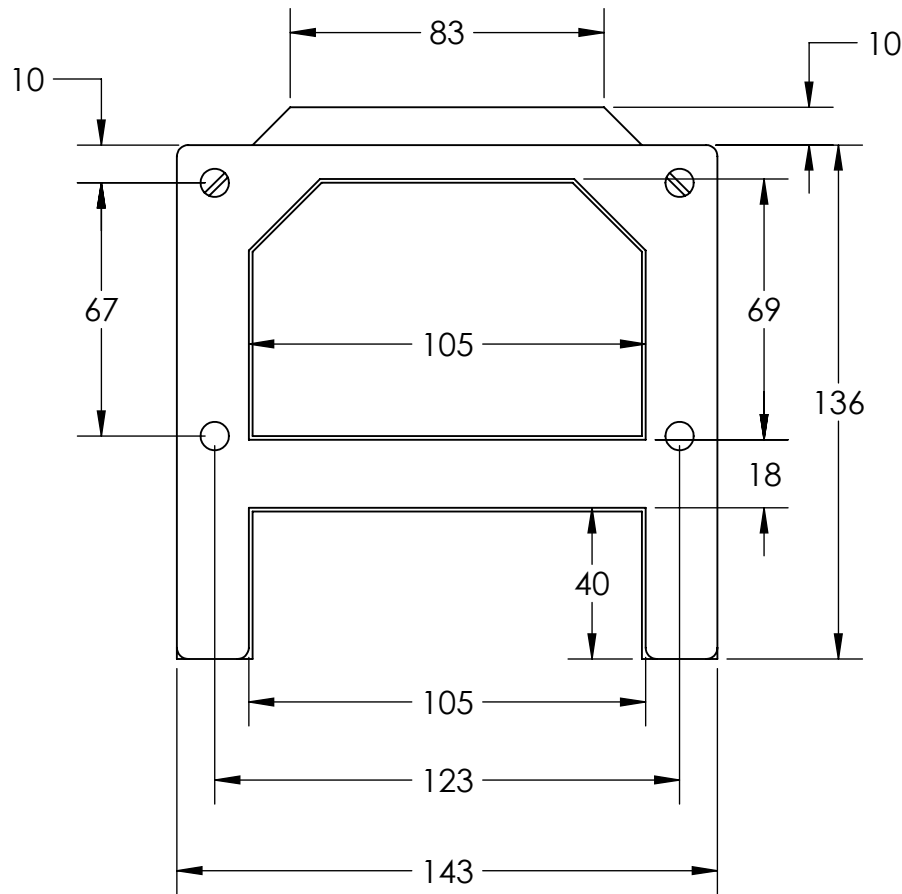

THIS DOCUMENT IS THE PROPERTY OF RICHARDSON ELECTRONICS, LTD. AND SHALL NOT BE COPIED, REPRODUCED, USED IN THE MANUFACTURE OR SALE OF APPARATUS OR DISCLOSED TO OTHERS WITHOUT PERMISSION.

Richardson Electronics, Ltd.  
40W267 Keslinger Road  
LaFox, IL 60147 USA

rellaser.com | laser@rell.com  
1.800.348.5580 (USA & Canada)  
1.630.208.2200 (International)